

Varenummer: 40550500302430  
 Beskrivelse: Tandhjulsgeær S501F-3-P80B5

## Mål

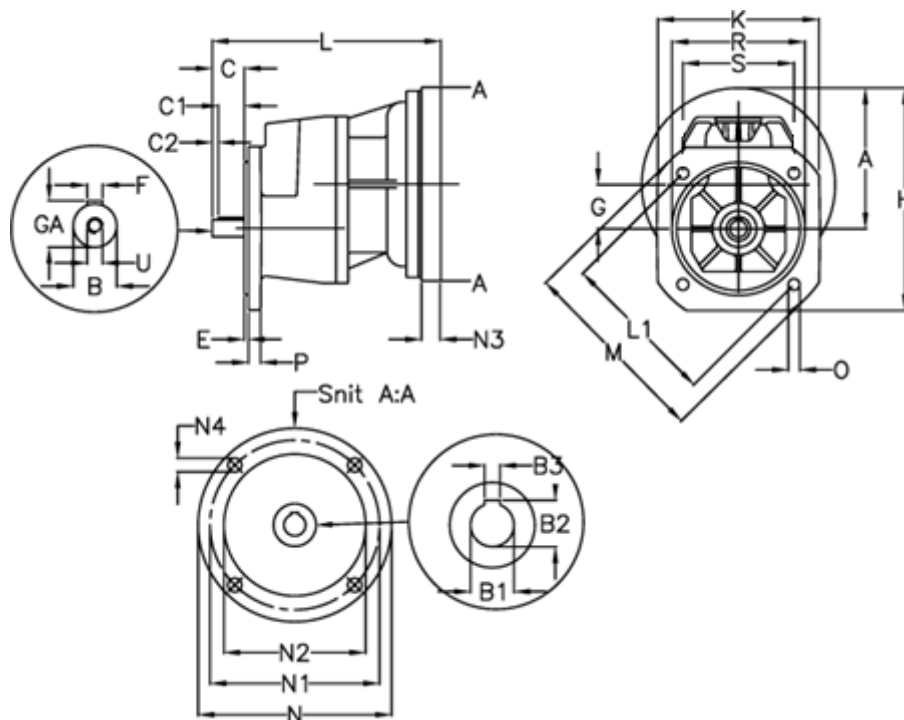

A = 196.5	E = 4.0	M = 300.0	R = 230
B = 38	F = 10x8x60	N = 200	S = 185
B1 = 19	G = 73.5	N1 = 165	U = M12
B2 = 21.8	GA = 41.0	N2 = 130	
B3 = 6	H = 326.5	N3 = -	
C = 80	K = 260	N4 = M10x12	
C1 = 60	L = 314	O = 14.0	
C2 = 10	L1 = 265.0	P = 15	